

ASSEMBLY INSTRUCTIONS

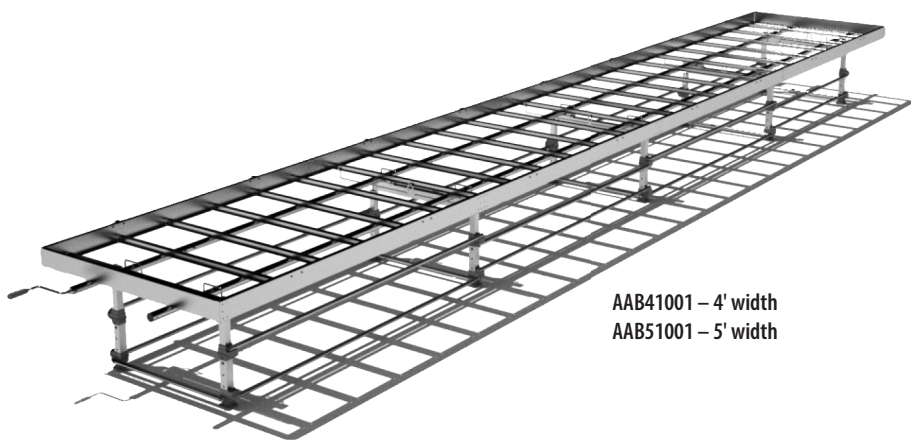

IZON ROLLING BENCH (KIT AAB41001 / AAB51001)



AAB41001 – 4' width
AAB51001 – 5' width

FR Instructions en Français disponibles sur [Hydrofarm.com](https://www.hydrofarm.com)

ES Instrucciones en Español disponibles en [Hydrofarm.com](https://www.hydrofarm.com)

START: It's important to always start with Kit **AAB42002/AAB52002** when you start building a new table.

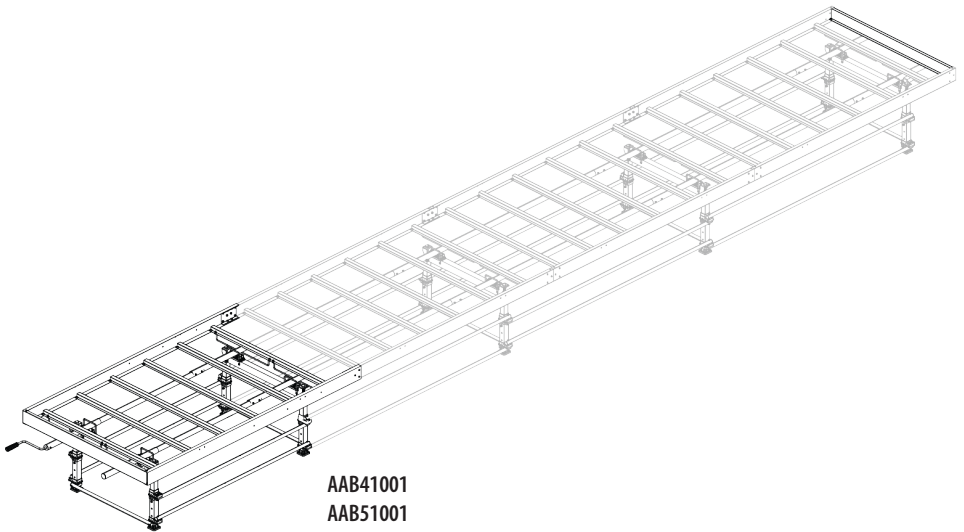

WARNING



















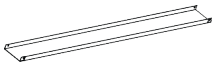









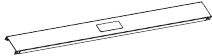
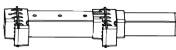



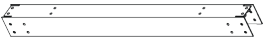

The **Active Aqua Rolling Bench (AAB41001/AAB51001 and AAB42002/AAB52002)** must always be placed on and anchored to a concrete surface that is level and void of any areas needing repair (cracked). Failure to properly secure the bench to the ground could result in the bench over-tipping unexpectedly.

- Only use approved anchors
- Do not load the Bench with more than 20 pounds per square foot when properly installed and bearing evenly distributed weight.
- Do not climb on or in the Bench or Trays.
- Keep fingers and hands away from the moving parts. The table sliders can cause injury.
- Keep fingers and hands away from the anti-tip brackets. Do not use the brackets to move the bench. Fingers or hands can be caught between the bracket and the frame causing injury.
- Do not extend threaded shafts more than the maximum spacing defined.
- Do not move the bench without making sure all people and animals are in a safe location.





IMPORTANT: Before you screw the table into the floor you **MUST:**

- Level the entire table
- Adjust the water dripping slope
- Adjust the length of the Kit **AAB41001/AAB51001**
- Make sure that the top of the table is in straight line

PARTS LIST (AAB41001 / AAB51001)





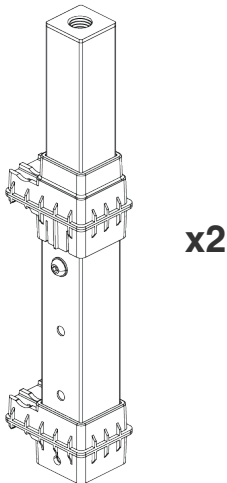
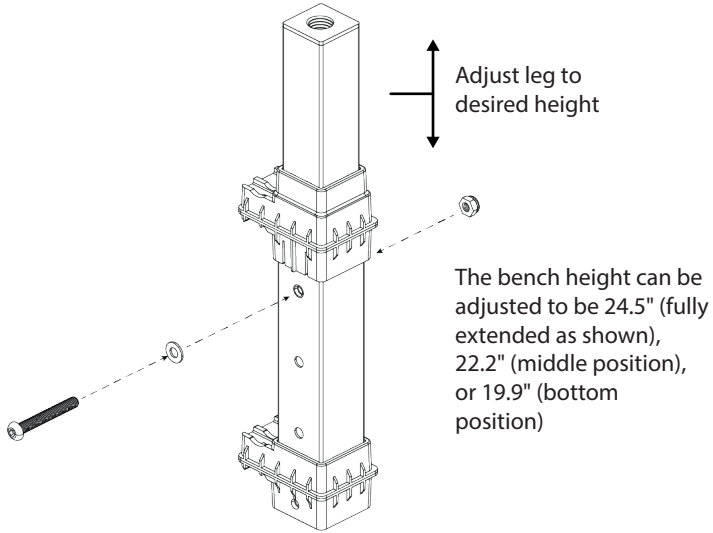

PART	QTY	DESCRIPTION	PART	QTY	DESCRIPTION
#1	x33	Bolt (M6*10L) 	#20	x2	Rolling Tube A 
#2	x56	Bolt (M6*20L) 	#22	x2	Rolling Tube C 
#3	x9	Bolt (M6*50L) 	#25	x2	Tray Beam A 
#4	x4	Bolt (M6*80L) 	#26	x4	Tray Beam B 
#5	x4	Bolt (M6*90L) 	#28	x1	End Plate 
#6	x17	Nut (M6) 	#29	x2	Side Panel C 
#7	x38	Washer (M6) 	#B-A	x2	Guide Wheel A 
#8	x4	Bolt (M8*65L) 	#B-B	x2	Guide Wheel B 
#9	x4	Nut (M8) 	#30	x6	U-Rod 
#10	x4	Washer (M8) 	#31	x1	Start Plate 
#11	x4	Leg 	#32	x1	Rod Retainer 
#12	x4	Tube Roller 	#33	x1	Handle Rod 
#13	x2	Bridge 	#34	x1	Handle 
#14	x4	Small U-Rod 	#35	x3	Round Cap 
#15	x4	Leveler 	ALSO INCLUDES ASSEMBLY TOOLS:		
#16	x4	Foot 	Hex Wrench 4mm (x2)		
#17	x2	Short Beam 	Open-Ended Wrench 10mm (x2)		
#19	x4	Adjustable Beam 	Hex Wrench 7mm (x2)		
			Open-Ended Wrench 14mm (x2)		

STEP 1: ADJUST THE LEGS

PART	QTY	DESCRIPTION		PART	QTY	DESCRIPTION	
#8	x2	Bolt (M8*65L)		#10	x2	Washer (M8)	
#9	x2	Nut (M8)		#11	x2	Leg	



STEP 2: ASSEMBLE THE BRIDGE

PART	QTY	DESCRIPTION		PART	QTY	DESCRIPTION	
#2	x14	Bolt (M6*20L)		#13	x1	Bridge	
#7	x2	Washer (M6)		#14	x2	Small U-Rod	
#12	x2	Tube Roller		#15	x2	Leveler	

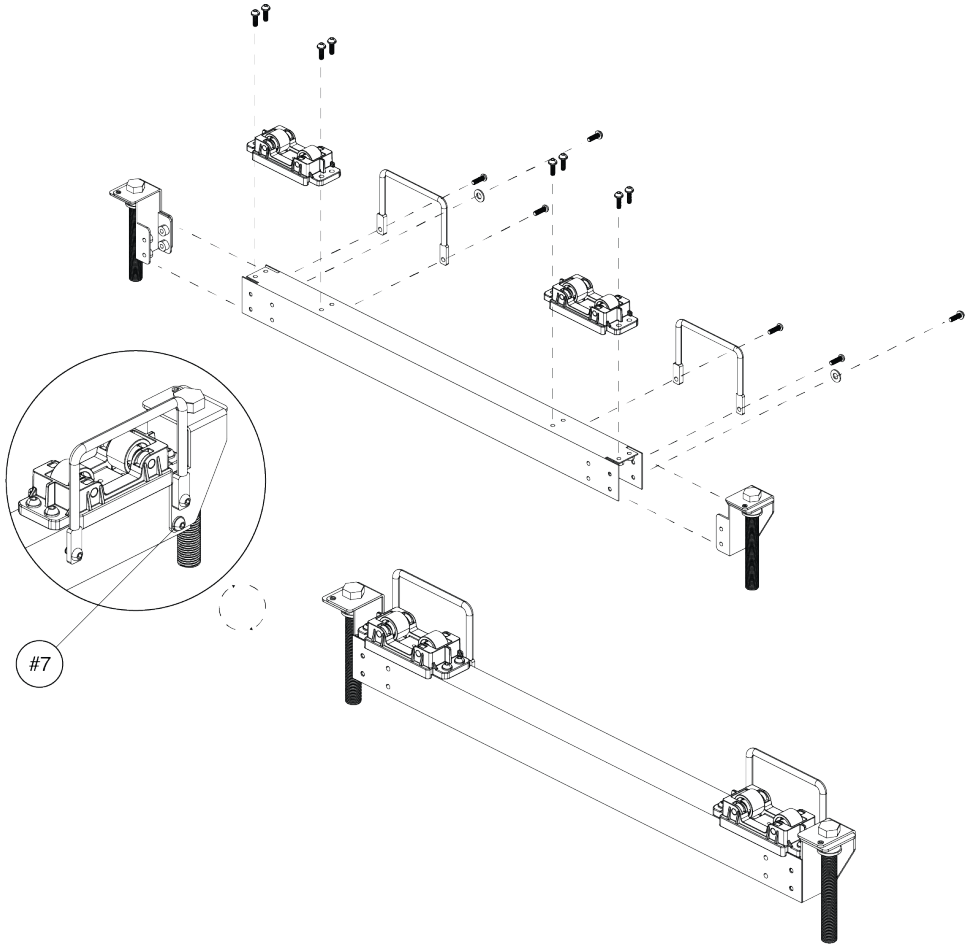



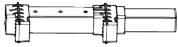
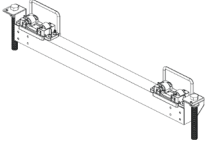

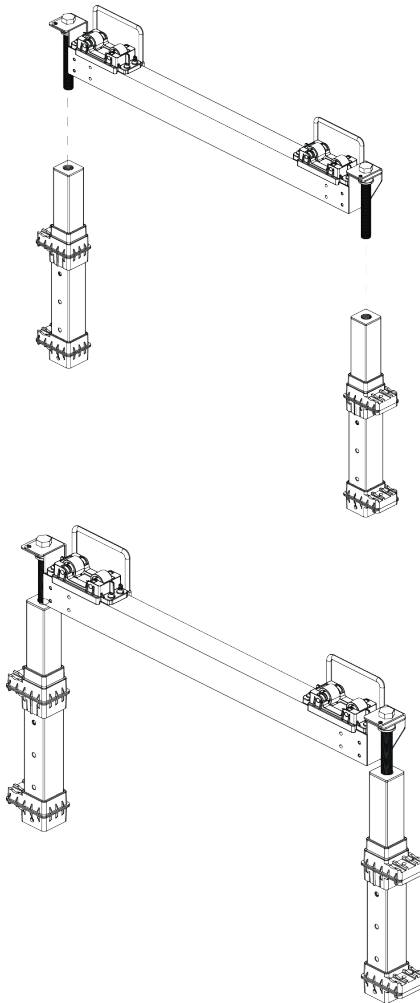

STEP 3: ASSEMBLE THE LEGS

PART	QTY	DESCRIPTION	PART	QTY	DESCRIPTION
#11	x2	Leg			
			x1		Bridge Assembly
					



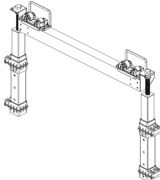

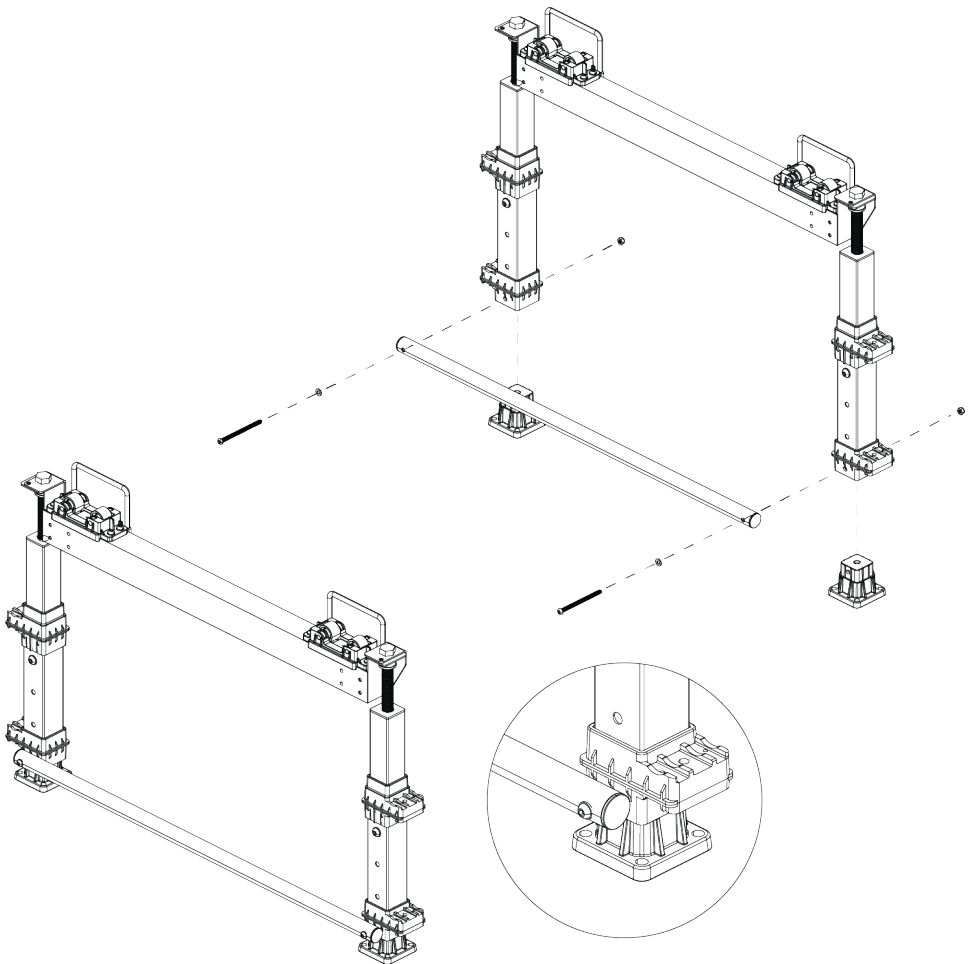

STEP 4: INSTALL THE SHORT BEAM

PART	QTY	DESCRIPTION		PART	QTY	DESCRIPTION	
#5	x2	Bolt (M6*90L)		#17	x1	Short Beam	
#6	x2	Nut (M6)					
#7	x2	Washer (M6)		x1		Leg Assembly	
#16	x2	Foot					

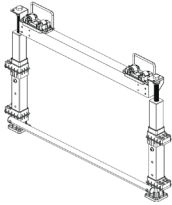

STEP 5: INSTALL THE ADJUSTABLE BEAMS

PART	QTY	DESCRIPTION	PART	QTY	DESCRIPTION
#3	x2	Bolt (M6*50L) 	#19	x4	Adjustable Beam 
#4	x2	Bolt (M6*80L) 		x1	Leg Assembly w/Short Beam 
#6	x2	Nut (M6) 			
#7	x2	Washer (M6) 			

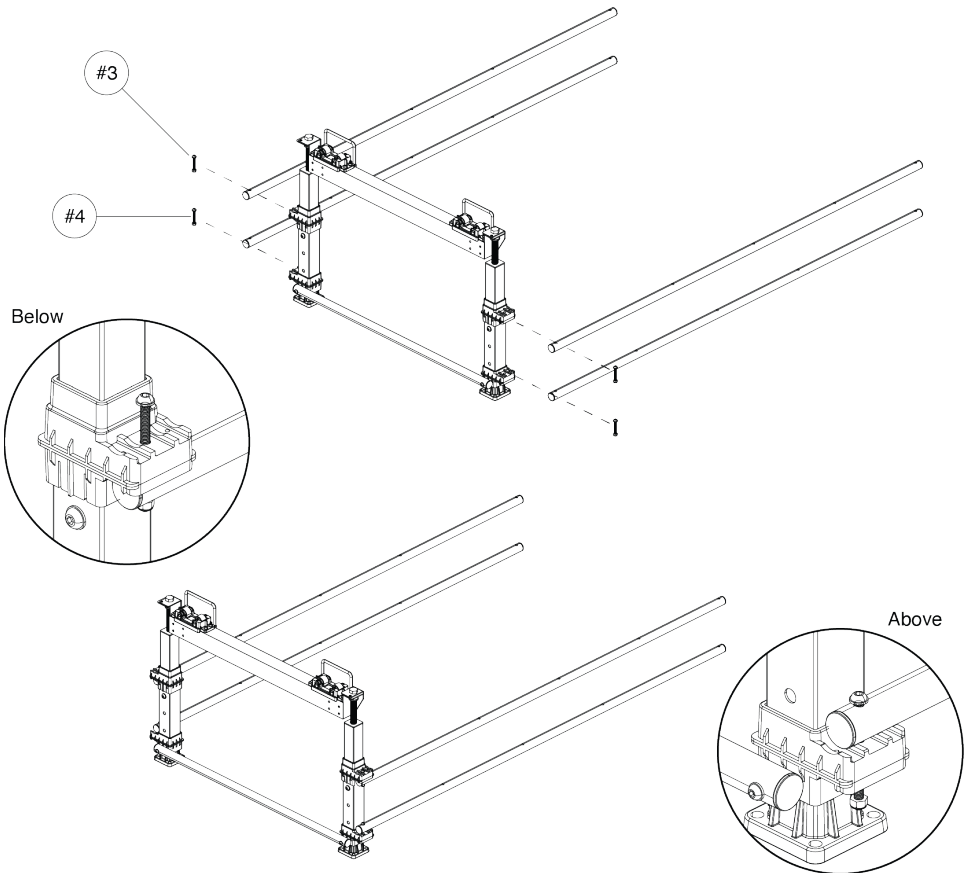



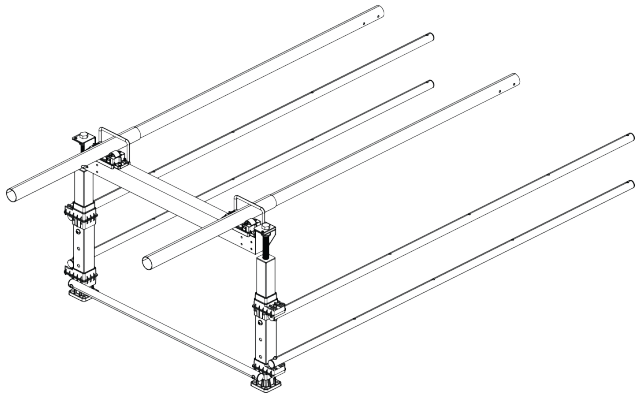
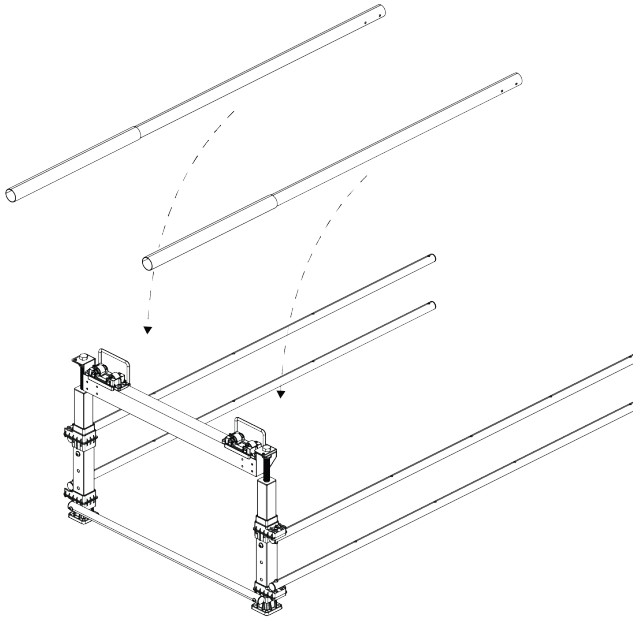

STEP 6: INSTALL THE ROLLING TUBES

PART QTY DESCRIPTION

#22 x2 Rolling Tube C

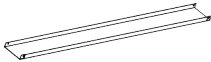

STEP 7: ASSEMBLE THE TABLE

PART	QTY	DESCRIPTION	PART	QTY	DESCRIPTION
#1	x28	Bolt (M6*10L) 	#28	x1	End Plate 
#25	x2	Tray Beam A 	#29	x2	Side Panel C 
#26	x4	Tray Beam B 			

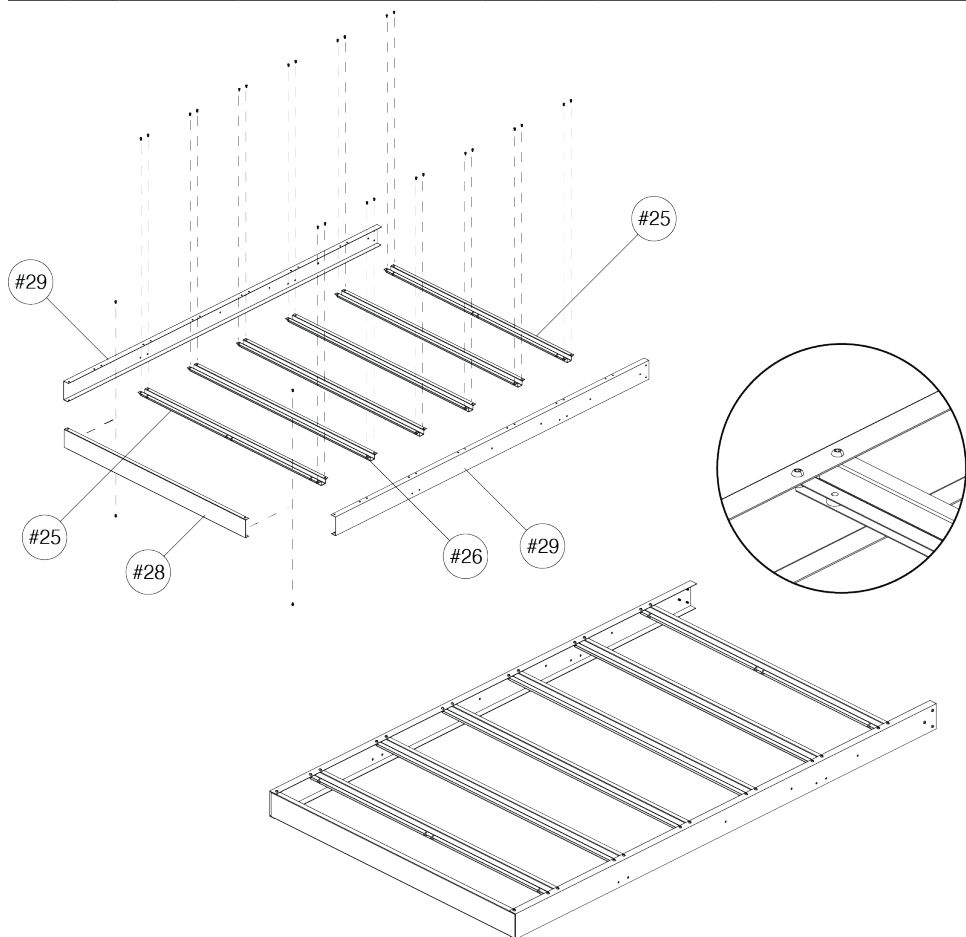



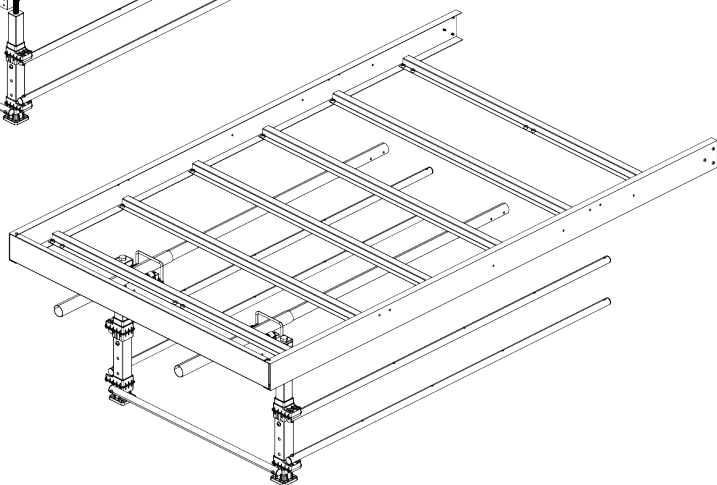
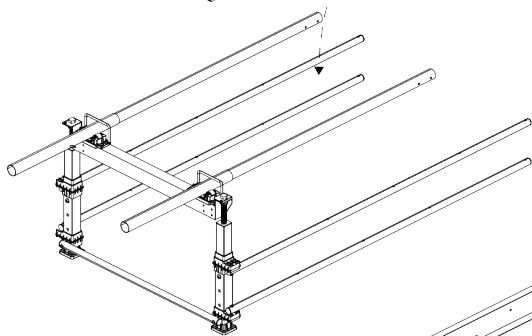
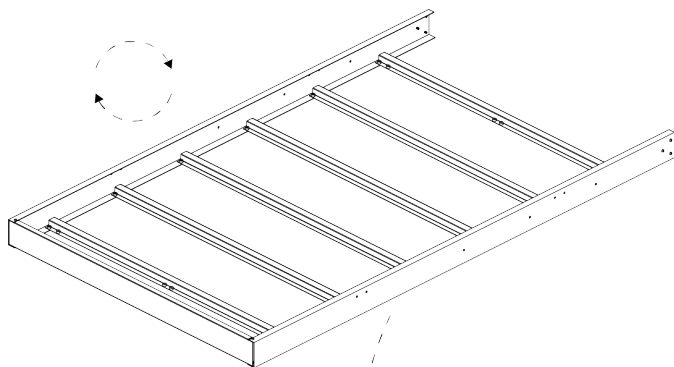
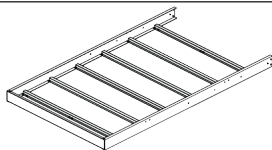

STEP 8: INSTALL THE TABLE

PART QTY DESCRIPTION

#1



STEP 9: INSTALL THE GUIDE WHEELS

PART	QTY	DESCRIPTION	PART	QTY	DESCRIPTION
#2	x8	Bolt (M6*10L) 	#B-A	x1	Guide Wheel A 
#7	x8	Bolt (M6*50L) 	#B-B	x1	Guide Wheel B 

The Guide Wheels need to be in the first Tray Beam.

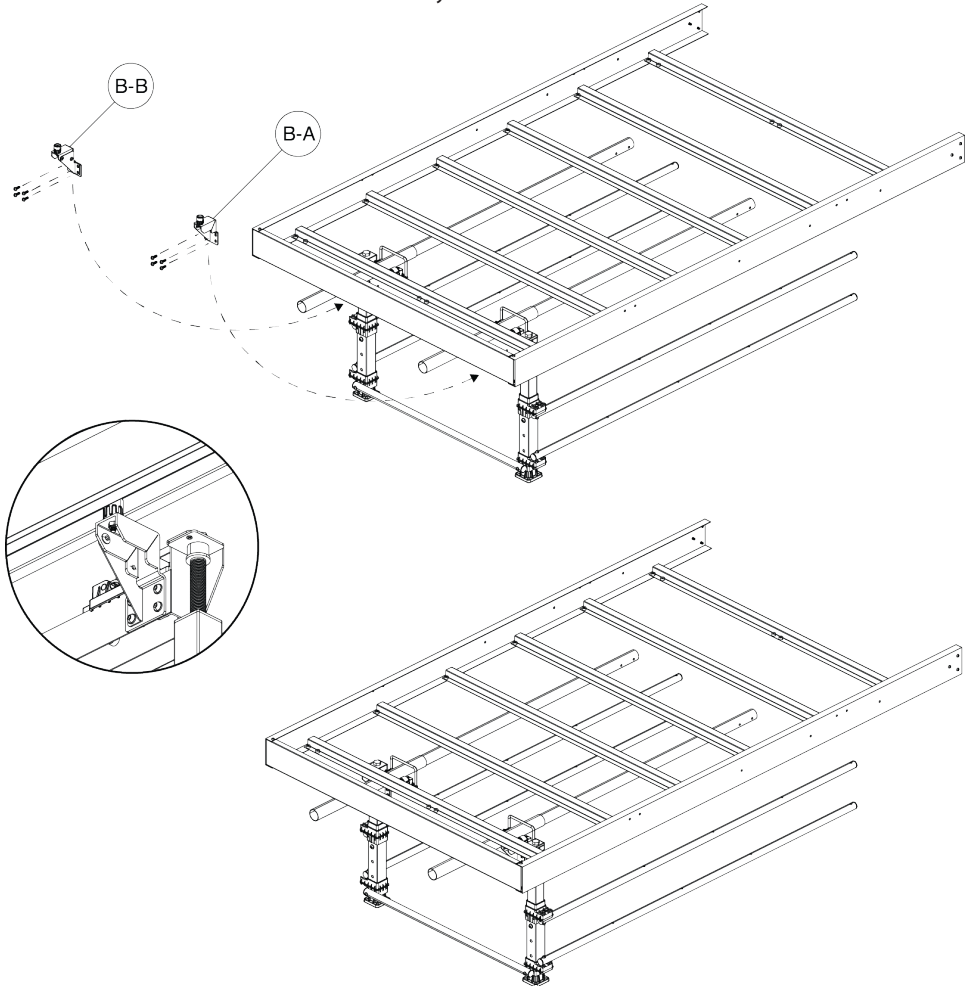

STEP 10: INSTALL THE U-RODS

PART QTY DESCRIPTION

#2 x8 Bolt (M8*20L)

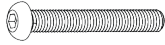

PART QTY DESCRIPTION

#30 x4 U-Rod

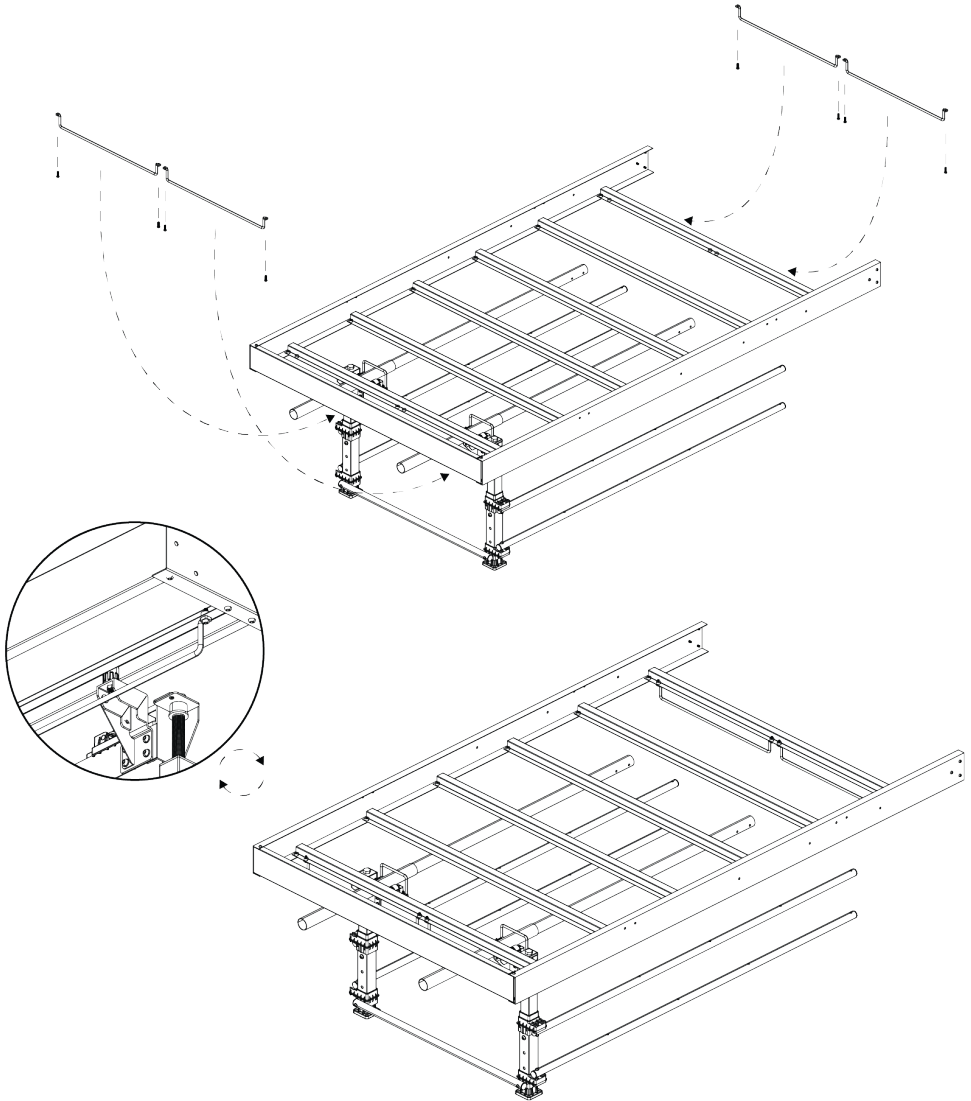



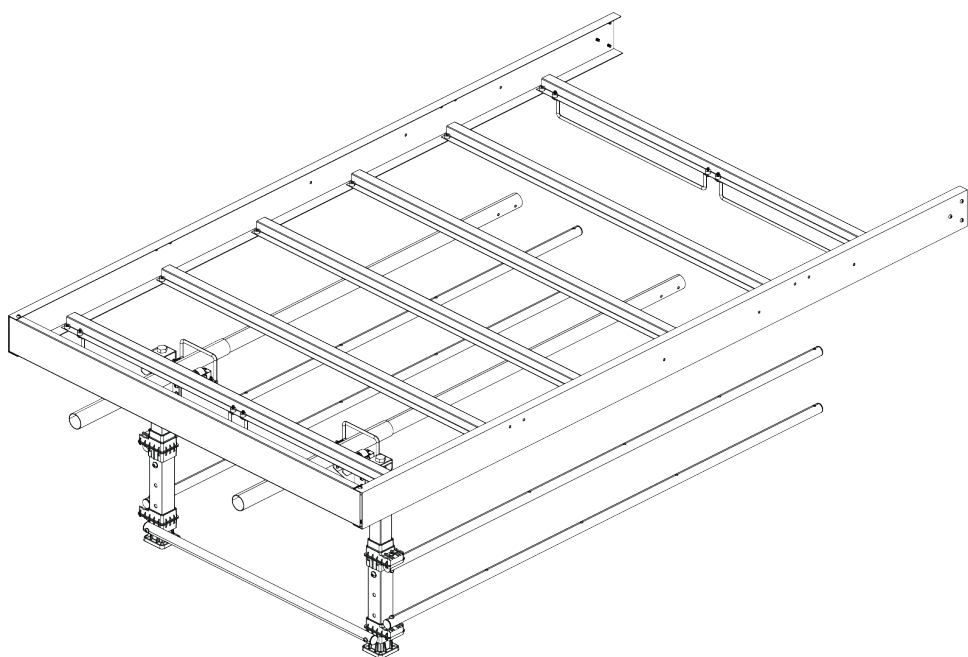











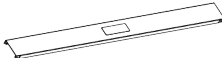







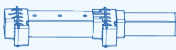

RESULT: KIT AAB41001 / AB51001



PART LIST

Blue highlight = Parts that will be used for **AAB42002/AAB52002** assembly.

PART	QTY	DESCRIPTION	PART	QTY	DESCRIPTION
#1	x44	Bolt (M6*10L) 	#B-A	x1	Guide Wheel A 
#2	x14	Bolt (M6*20L) 	#B-B	x1	Guide Wheel B 
#3	x8	Bolt (M6*50L) 	#30	x2	U-Rod 
#4	x4	Bolt (M6*80L) 	#31	x1	Start Plate 
#5	x2	Bolt (M6*90L) 	#32	x1	Rod Retainer 
#6	x14	Nut (M6) 	#33	x1	Handle Rod 
#7	x16	Washer (M6) 	#34	x1	Handle 
#8	x2	Bolt (M8*65L) 	#35	x3	Round Cap 
#9	x2	Nut (M8) 			
#10	x2	Washer (M8) 			
#11	x2	Leg 			
#12	x2	Tube Roller 			
#13	x1	Bridge 			
#14	x2	Small U-Rod 			
#15	x2	Leveler 			
#16	x2	Foot 			
#17	x1	Short Beam 			
#20	x2	Rolling Tube A 			

WARRANTY



LIMITED WARRANTY

Hydrofarm warrants the **AAB41001** and **AAB51001** to be free from defects in materials and workmanship. The warranty term is for 1 year beginning on the date of purchase. Misuse, abuse, or failure to follow instructions is not covered under this warranty. Hydrofarm's warranty liability extends only to the replacement cost of the product. Hydrofarm will not be liable for any consequential, indirect, or incidental damages of any kind, including lost revenues, lost profits, or other losses in connection with the product. Some states do not allow limitation on how long an implied warranty lasts or the exclusion of incidental or consequential damages, so the above limitations or exclusions may not apply to you. Hydrofarm will, at our discretion, repair or replace the **AAB41001** and **AAB51001** covered under this warranty if it is returned to the original place of purchase. To request warranty service, please return the **AAB41001** and **AAB51001**, with original sales receipt and original packaging, to your place of purchase. The purchase date is based on your original sales receipt.

GARANTIE LIMITÉE

Hydrofarm garantit que le moniteur **AAB41001** et **AAB51001** ne présente aucun défaut de pièces et main-d'œuvre. La période de garantie est de 1 an à partir de la date d'achat. Une utilisation incorrecte, abusive, ou le non-respect des instructions n'est pas couvert (e) par cette garantie. La responsabilité de la garantie Hydrofarm couvre uniquement le coût de remplacement du produit. Hydrofarm ne pourra être tenu responsable des dommages consécutifs, indirects ou fortuits de tout type, y compris les pertes de revenus, de profits ou autres en rapport avec le produit. Certains états n'autorisent aucune limite concernant la durée de la garantie implicite ou l'exclusion des dommages fortuits ou consécutifs ; les limites ou exclusions mentionnées ci-dessus peuvent donc ne pas être applicables à votre cas. Hydrofarm se réserve le droit de réparer ou remplacer le moniteur **AAB41001** et **AAB51001** couvert par cette garantie si celui-ci est renvoyé au lieu d'achat d'origine. Pour solliciter le service de garantie, veuillez renvoyer le moniteur **AAB41001** et **AAB51001** avec sa facture et son emballage à votre lieu d'achat. La date d'achat est indiquée sur votre facture originale.

GARANTÍA LIMITADA

Hydrofarm garantiza que **AAB41001** y **AAB51001** no presenta defectos de fabricación. La garantía tendrá una duración de 1 año desde la fecha de compra. En caso de no respetarse estas instrucciones o de un uso inadecuado del producto, la garantía no cubrirá los posibles daños. La cobertura de la garantía ofrecida por Hydrofarm únicamente incluye los costes de sustitución del producto. Hydrofarm no será responsable de ningún daño indirecto, accidental o derivado de ningún tipo, incluyendo pérdidas de ingresos o beneficios, o cualquier otra pérdida relacionada con el producto. En algunos estados no se permiten limitaciones sobre la duración de una garantía implícita o la exclusión de los daños accidentales o derivados; en cuyo caso las limitaciones y exclusiones anteriores no serán de aplicación. Hydrofarm, a su discreción, podrá reparar o sustituir **AAB41001** y **AAB51001** que cubre la presente garantía siempre que se devuelva al lugar original de compra. Para reclamar la garantía, devuelva **AAB41001** y **AAB51001** con el ticket de compra y el embalaje original al lugar de compra. La fecha de compra será la indicada en el ticket original.



Thank you for choosing Active Aqua by Hydrofarm. For further information about Hydrofarm products, videos and technical information, please visit Hydrofarm.com.

Get Connected with the Hydrofarm Community:



Like us on Facebook, follow us on Twitter, and check out Hydrofarmtv on YouTube and Instagram!

AAB41001_AAB51001_instructions_July2022 | rev. 7/20/2022 5:22pm